



















SERIES FEATURES

-  Intensive use
-  Network interface
-  Motors powered by 24V
-  Magnetic encoder control
-  Opening and closing deceleration system
-  Master - Slave setting
-  Built-in programmer
-  Self-learning
-  Multi-decoding
-  Built-in radio receiver card
-  Bluetooth compatible

PRODUCT FEATURES

-  Graphic LCD display
-  Real-time clock
-  Maximum gate weight 1500kg
-  Industrial building
-  Collective housing

Characteristics SLX24 SERIES

Self-programming automation for residential and industrial sliding gates up to 3000kg

A “complete machine” which contains all the electronic and mechanical components required to manage gate positioning and the safety functions of the installation. Powerful and tireless, controlled by state of the art electronics, the automation is fitted with a powerful direct current motor backed up by a finely tuned double gear kinematic system which reduces the stress on the motor and structure caused by the movement of heavy gates.

Self-locking and reversible electromechanical automation system with a low voltage motor for residential & industrial sliding gates with a maximum weight of 3000kg.

Installation is possible on any structure and the unit may be fitted both to the right as well as to the left of the passageway.

The use of low voltage motors increase the performance, guarantee high efficiency, long life and silent running.

The integrated programmer allows encoder-controlled gate positioning and self-programming thus reducing installation times to a minimum and optimising the programming procedure. Repositioning takes place automatically whenever foreign objects get in the way of the gate as it is moving. The electronic control unit is completed by the anti-crush and “soft start” and “soft stop” functions.

Compatible with the INTPRG-3G/WF system that allows the system parameters to be controlled and programmed remotely.

A slave motor, connected via cable with the Cardin MODCA slot-in modules inserted, can be installed to drive two biparting sliding gates.

Multi-decoding

The product range is factory fitted with a multi-decoding remote control module (system S449 - S486 - S504 - S508). By default the devices are supplied with a 433MHz RF module and the S504 / S508 series memory module inserted. To control the device with S449 transmitters, insert the ZGB24LC16-I / P memory module (supplied with the device) and consult the relevant section. For the S508 / S486 series purchase and insert the 868Mhz RF module.

Product features SLX1524

Electromechanical unit with a 24V motor

The electronic programmer is factory fitted with a graphic LCD display (128 x 128 pixels) with backlighting in six different languages. The menu allows you to rapidly set the system parameters including: the sequential button mode, automatic reclosing, warning lamp pre-flashing, intermittent warning lamp activation, indicator light and photoelectric cell function setting etc. The electronics card, thanks to the presence of the real-time clock, allows you to set 10 events (shown on the display) and these events permit you to regulate the opening and closing of the motor at different times during the day within 3 weekly time bands (Mon-Fri, Sat-Sun, Mon-Sun); the events can be enabled or disabled (during holiday periods) either from the menu or by means of a radio channel.

The appliance is fitted with a safe and secure manual release system activated by a personalised key.

Max. drag speed 9.5 m/min.

The appliance is fitted with a safe and secure manual release system activated by a personalised key.

Max. drag speed 9.5 m/min.



> ULTIMATE CARDIN App

SLX1524 - AUTOMATION FOR SLIDING GATES

Electromechanical unit with a 24V motor

GENERAL CHARACTERISTICS

Single phase mains power supply 50/60Hz	Vac	230
Power input	W	200
Nominal electrical input	A	0.9
Motor power supply	Vac	24
Maximum motor power yield	W	130
Nominal electrical input motor	A	3.5
Duty cycle	%	70
Drag speed	m/min	9.5
Torque max.	Nm	74
Incorporated batteries	typ	NiMH
Operating temperature range	°C	-20...+55
Protection grade	IP	44
Insulation class	Cls	II

CONNECTIVITY

Optional WIFI module	INTPRG-WIFI
Bluetooth interface module	MODBT

POSITIONING THE UNIT

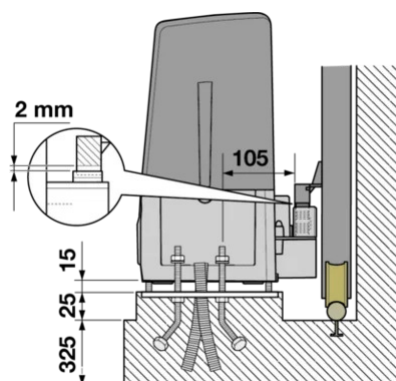

OVERALL DIMENSIONS

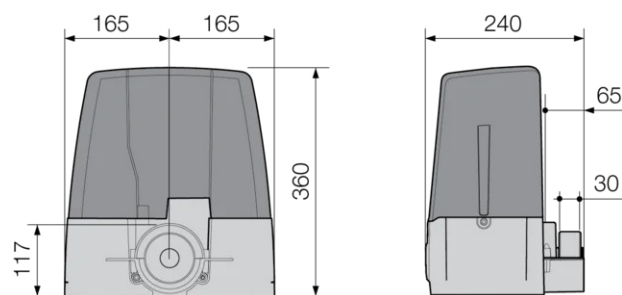

FASTENING BASE

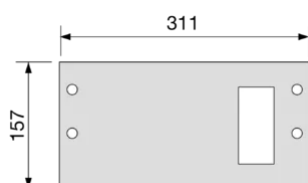

> ULTIMATE CARDIN App