





















SERIES FEATURES

-  Intensive use
-  Network interface
-  Motors powered by 24V
-  Magnetic encoder control
-  Opening and closing deceleration system
-  Master - Slave setting
-  Built-in programmer
-  Self-learning
-  Multi-decoding
-  Built-in radio receiver card
-  Bluetooth compatible

PRODUCT FEATURES

-  Graphic LCD display
-  Real-time clock
-  Maximum gate weight 1000kg
-  Variable speed
-  Temperature detection
-  Collective housing
-  Residential housing

Characteristics SLX24DRACO SERIES

Self-programming automation for residential, industrial and collective sliding gates up to 2000kg

A “complete machine” which contains all the electronic and mechanical components required to manage gate positioning and the safety functions of the installation. Powerful and tireless, controlled by state of the art electronics, the automation is fitted with a powerful direct current motor backed up by a finely tuned double gear kinematic system which reduces the stress on the motor and structure caused by the movement of heavy gates.

DRACO is an innovative system for moving residential, industrial and collective sliding doors and gates at variable speeds up to 30m per minute.

Installation is possible on any structure and the unit may be fitted both to the right as well as to the left of the passageway.

The use of low voltage motors increase the performance, guarantee high efficiency, long life and silent running.

The integrated programmer allows encoder-controlled gate positioning and self-programming thus reducing installation times to a minimum and optimising the programming procedure. Repositioning takes place automatically whenever foreign objects get in the way of the gate as it is moving. The electronic control unit is completed by the anti-crush and “soft start” and “soft stop” functions.

Compatible with the INTPRG-3G/WF system that allows the system parameters to be controlled and programmed remotely.

A slave motor, connected via cable with the Cardin MODCA slot-in modules inserted, can be installed to drive two biparting sliding gates.

Multi-decoding

The product range is factory fitted with a multi-decoding remote control module (system S449 - S486 - S504 - S508). By default the devices are supplied with a 433MHz RF module and the S504 / S508 series memory module inserted. To control the device with S449 transmitters, insert the ZGB24LC16-I / P memory module (supplied with the device) and consult the relevant section. For the S508 / S486 series purchase and insert the 868Mhz RF module.

Product features SLX24DRACO

Electromechanical unit with a 24V motor

The innovative DRACO system permits the gate's movement to be accompanied with total security and features a “variable speed function” which can be adjusted according to the different installation requirements up to a maximum speed of 30m per minute.

The electronic programmer is factory fitted with a graphic LCD display (128 x 128 pixels) with backlighting in six different languages. The menu allows you to rapidly set the system parameters including: the sequential button mode, automatic reclosing, warning lamp pre-flashing, intermittent warning lamp activation, indicator light and photoelectric cell function setting etc. The electronics card, thanks to the presence of the real-time clock, allows you to set 10 events (shown on the display) and these events permit you to regulate the opening and closing of the motor at different times during the day within 3 weekly time bands (Mon-Fri, Sat-Sun, Mon-Sun); the events can be enabled or disabled (during holiday periods) either from the menu or by means of a radio channel.

The appliance is fitted with a safe and secure lever operated manual release system protected by a robust access door with a personalised key.

Max. drag speed 30 m/min.

Optional NiMH batteries and battery charger.



> ULTIMATE CARDIN App

SLX24DRACO - AUTOMATION FOR SLIDING GATES

Electromechanical unit with a 24V motor



GENERAL CHARACTERISTICS

Single phase mains power supply 50/60Hz	Vac	230
Power input	W	380
Nominal electrical input	A	1.7
Motor power supply	Vac	24
Maximum motor power yield	W	250
Nominal electrical input motor	A	10
Duty cycle	%	50
Drag speed	m/min	30
Torque max.	Nm	44
Incorporated batteries	typ	NiMH
Operating temperature range	°C	-20...+55
Protection grade	IP	44
Insulation class	Cls	II

CONNECTIVITY

Optional WIFI module	INTPRG-WIFI
Optional Bluetooth interface module	MODBT

POSITIONING THE UNIT

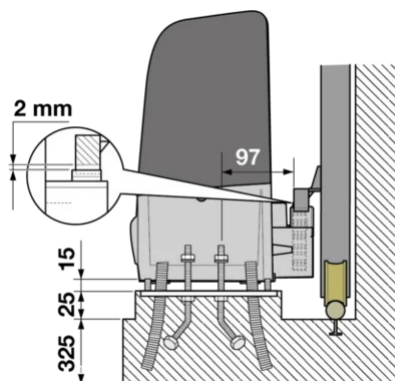

OVERALL DIMENSIONS

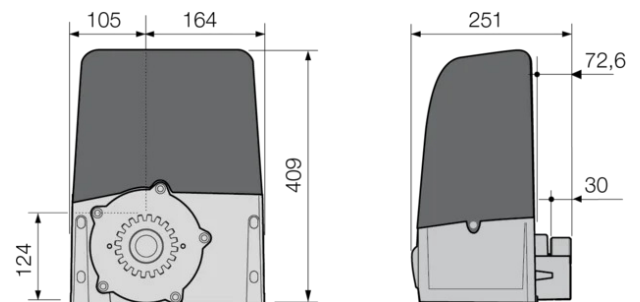

FASTENING BASE

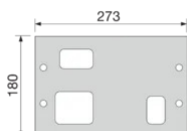

> ULTIMATE CARDIN App